

Kompaktanlage Wärmeträger-Erhitzer
Compact thermal oil heating plant
Typ/ Type: 800/30

Regiomat®

Advance in heat transfer technology

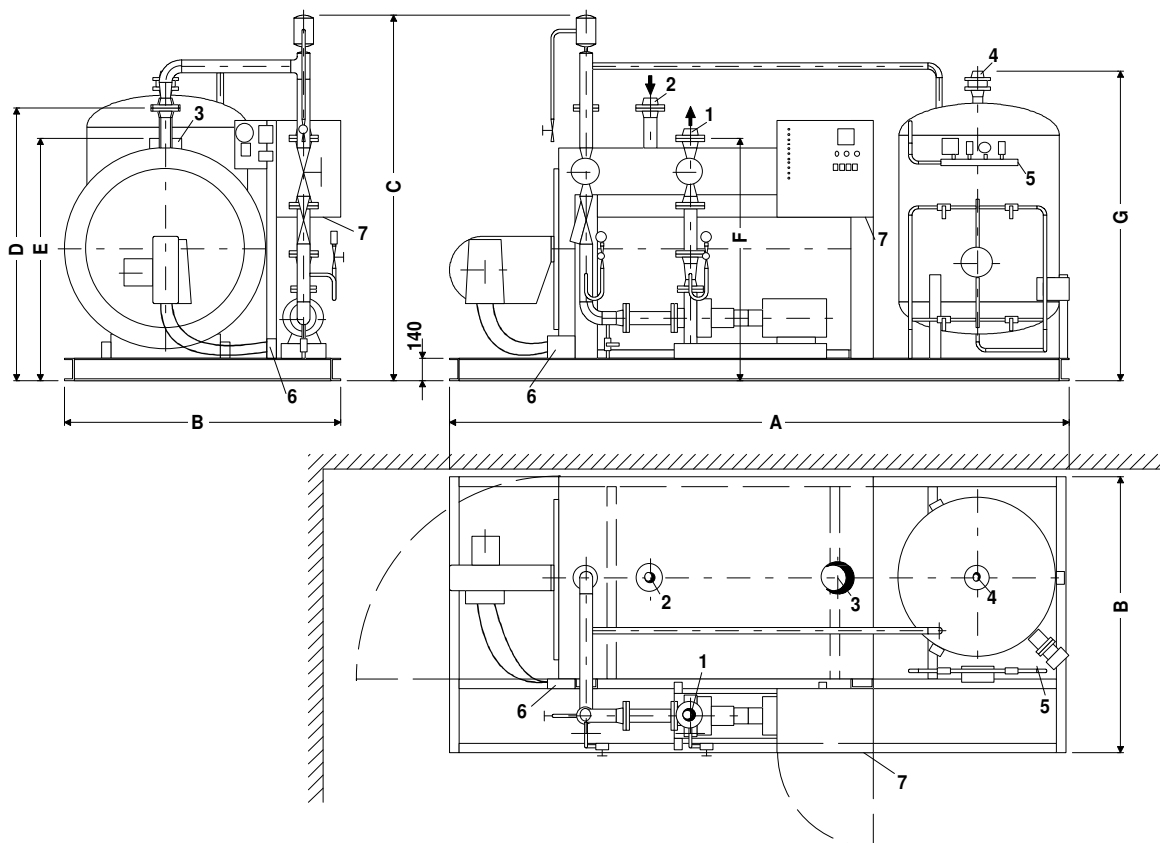

Erhitzer	Heater	Typ	800/30
Wärmeleistung	Heating capacity	kW	800
Volumenstrom	Flow rate	m ³ /h	45
Pumpe	Pump	Typ	NTT 50-200/01/193/11
Leichtöl-Brenner	Burner leight oil	Typ	Weishaupt
Kombinationsgefäß	Combination tank	Typ	1500
Füllmenge	Oil filling capacity	ltr.	885
Max. zul. Anlageinhalt	Ma. Instal. filling rate	ltr.	2106
Leergewicht	Weight empty	Kg	3740
Elektr. Anschlusswert	Electr. connection	kW	13
Spannung	Tension	V/Hz	3 x 400 V / 50 Hz

Anschlüsse / Connections			Masse / Measurements	
1 Vorlauf	Outlet	DN 80 PN 16	A	4700 mm
2 Rücklauf	Return	DN 80 PN 16	B	2100 mm
3 Kaminanschluss	Chimney	303 mm	C	2616 mm
4 Sicherheitsleitung	Safety line	DN 50 PN 16	D	2036 mm
5 Stickstoffanschluss	Nitrogen	1/4"	E	1850 mm
6 Oelanschluss	Leight oil	1/2"	F	1485 mm
7 Elektroanschluss	electr. supply	PG	G	2223 mm