

Kompaktanlage Wärmeträger-Erhitzer
Compact thermal oil heating plant
Typ/ Type: 500/30

Regiomat®

Advance in heat transfer technology

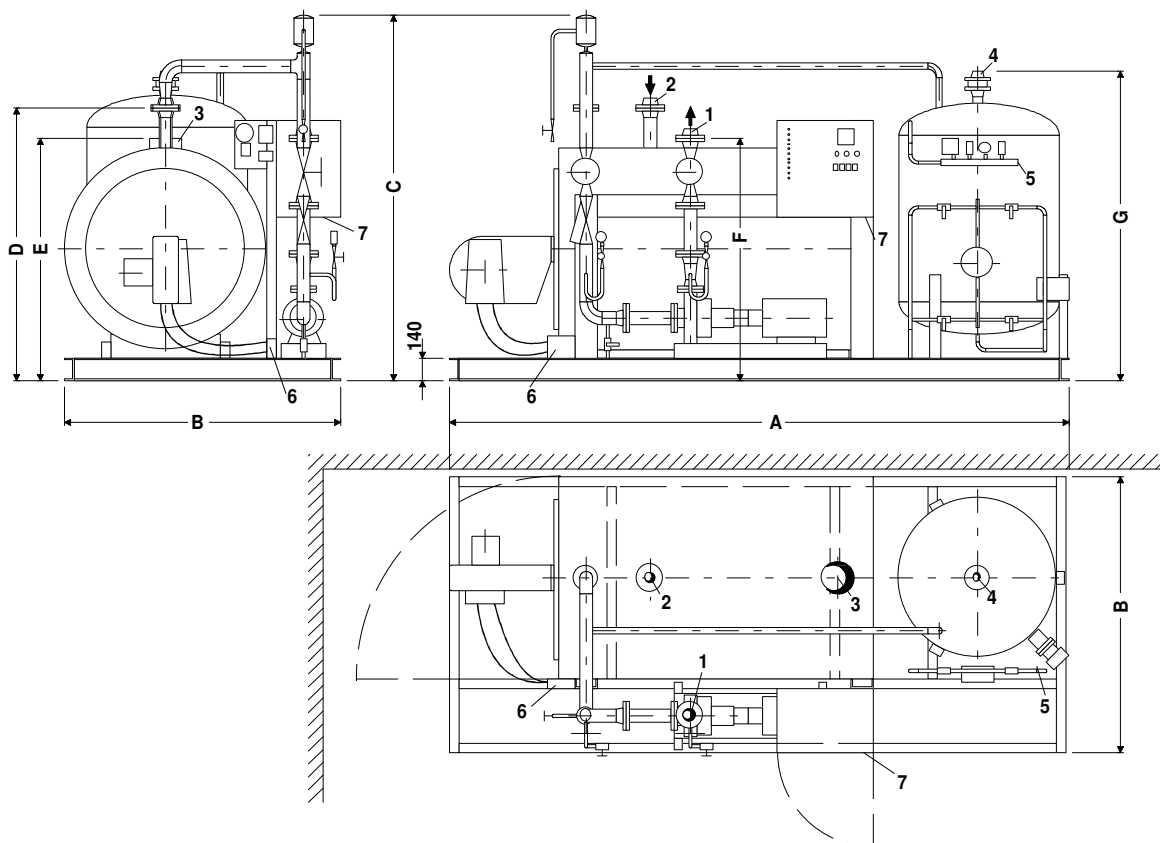

Erhitzer	Heater	Typ	500/30
Wärmeleistung	Heating capacity	kW	500
Volumenstrom	Flow rate	m ³ /h	29
Pumpe	Pump	Typ	NTT 40-200/01/179/5.5
Leichtöl-Brenner	Burner leight oil	Typ	Weishaupt
Kombinationsgefäß	Combination tank	Typ	1000
Füllmenge	Oil filling capacity	ltr.	593
Max. zul. Anlageinhalt	Ma. Instal. filling rate	ltr.	1335
Leergewicht	Weight empty	Kg	2320
Elektr. Anschlusswert	Electr. connection	kW	7
Spannung	Tension	V/Hz	3 x 400 V / 50 Hz

Anschlüsse / Connections			Masse / Measurements	
1 Vorlauf	Outlet	DN 65 PN 16	A	4200 mm
2 Rücklauf	Return	DN 65 PN 16	B	1850 mm
3 Kaminanschluss	Chimney	263 mm	C	2356 mm
4 Sicherheitsleitung	Safety line	DN 50 PN 16	D	1856 mm
5 Stickstoffanschluss	Nitrogen	1/4"	E	1670 mm
6 Oelanschluss	Leight oil	1/2"	F	1445 mm
7 Elektroanschluss	electr. supply	PG	G	1885 mm