

Kompaktanlage Wärmeträger-Erhitzer
Compact thermal oil heating plant
Typ/ Type: 400/30

Regiomat®

Advance in heat transfer technology

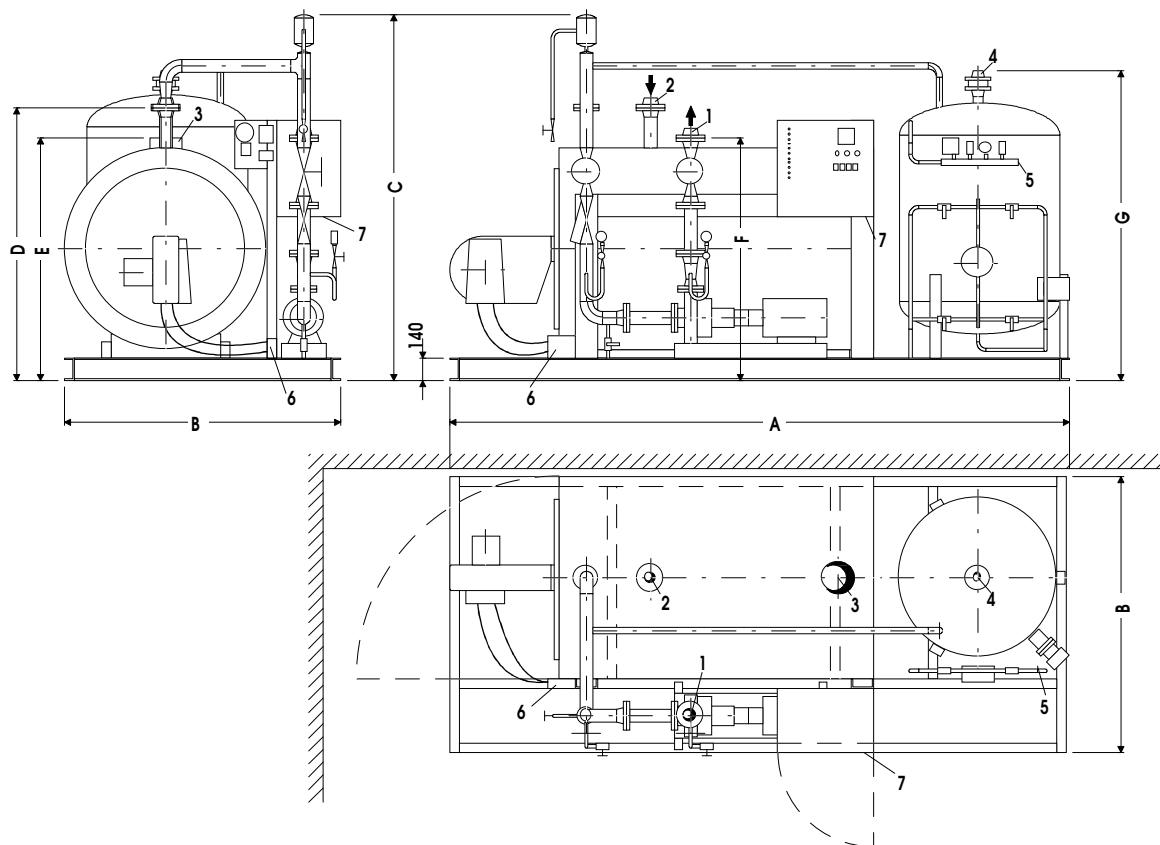

Erhitzer	Heater	Typ	400/30
Wärmeleistung	Heating capacity	kW	400
Volumenstrom	Flow rate	m ³ /h	23
Pumpe	Pump	Typ	NTT 40-200/01/178/5.5
Leichtöl-Brenner	Burner leight oil	Typ	Weishaupt
Kombinationsgefäß	Combination tank	Typ	1000
Füllmenge	Oil filling capacity	ltr.	447
Max. zul. Anlageinhalt	Ma. Instal. filling rate	ltr.	1335
Leergewicht	Weight empty	Kg	2000
Elektr. Anschlusswert	Electr. connection	kW	7
Spannung	Tension	V/Hz	3 x 400 V / 50 Hz

Anschlüsse / Connections			Masse / Measurements	
1 Vorlauf	Outlet	DN 50 PN 16	A	4000 mm
2 Rücklauf	Return	DN 50 PN 16	B	1700 mm
3 Kaminanschluss	Chimney	210 mm	C	2195 mm
4 Sicherheitsleitung	Safety line	DN 50 PN 16	D	1556 mm
5 Stickstoffanschluss	Nitrogen	1/4"	E	1510 mm
6 Oelanschluss	Leight oil	1/2"	F	1445 mm
7 Elektroanschluss	electr. supply	PG	G	1885 mm